

Pressure Independent Valve, 2-way, Internal thread, (EPIV)

- Nominal voltage AC/DC 24 V
- Control modulating, communicative, Hybrid
- For closed chilled and hot water systems
- For modulating control of air-handling and heating systems on the water side
- Communication via BACnet MS/TP, Modbus RTU, Belimo-MP-Bus or conventional control
- Conversion of active sensor signals and switching contacts
- Thermostat controlled internal heater

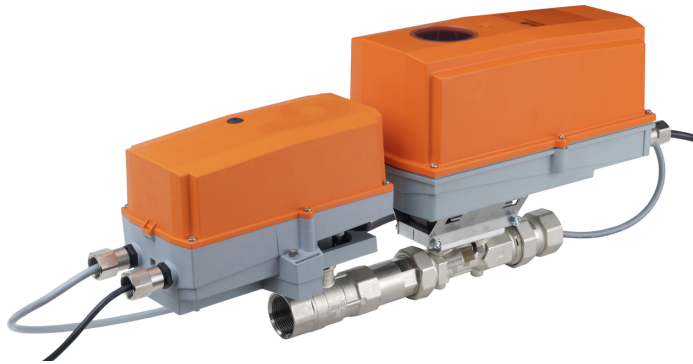

5-year warranty



Technical data

Electrical data	Nominal voltage	AC/DC 24 V
	Nominal voltage frequency	50/60 Hz
	Nominal voltage range	AC 19.2...28.8 V / DC 21.6...28.8 V
	Power consumption in operation	35W incl. heater
	Transformer sizing	44 VA incl. heater
	Connection supply / control	cable 3 ft. [1 m], 6 x 0.75 mm ²
	Conductors, cables	AC/DC 24 V, cable length <100 m
Data bus communication	Communicative control	BACnet MS/TP Modbus RTU MP-Bus
Functional data	Valve size [mm]	1.5" [40]
	Operating range Y	2...10 V
	Operating range Y note	4...20 mA w/ ZG-R01 (500 Ω, 1/4 W resistor)
	Input impedance	100 kΩ (0.1 mA), 500 Ω
	Operating range Y variable	0.5...10 V
	Operating modes optional	VDC variable
	Position feedback U	2...10 V
	Position feedback U note	Max. 1 mA
	Position feedback U variable	VDC variable
	Setting fail-safe position	NC/NO or adjustable 0...100% (POP rotary knob)
	Bridging time (PF) variable	0...10 s
	Running Time (Motor)	90 s
	Running time fail-safe	<35 s
	Sound power level Motor	45 dB(A)
	Noise level, fail-safe	61 dB(A)
	Adjustable flow rate V'max	25...100% of V'nom
	Control accuracy	±5%
	Min. controllable flow	1% of V'nom
	Configuration	via NFC, Belimo Assistant App
	Fluid	Chilled or hot water, up to 60% glycol max (open loop/steam not allowed)
	Fluid temperature	-10...120°C [14...250°F]
Close-off pressure Δps	200 psi	

Functional data	Differential Pressure Range	5...50 psi or 1...50 psi see flow reductions chart in tech doc
	Flow characteristic	equal percentage or linear
	Body Pressure Rating	360 psi
	Leakage rate	0% leakage
	GPM	44
	Installation position	upright to horizontal (in relation to the stem)
	Servicing	maintenance-free
	Manual override	external push button
Thermostat / Humidistat	Type of contact	Normally closed contact
	Heating output	21 W
	Switch-on current	Max. 2.5 A
	Thermostat range	14...122°F [-10...50°C] (factory setting 86°F [30°C])
	Heating element	Positive temperature coefficient resistor (PTC), self-regulating, temperature-limiting
	Heater	Aluminium profile, anodized
	Sensor element	Thermobimetal
	Measuring data	Measured values
Flow measurement	Measuring principle	Ultrasonic volumetric flow measurement
	Measuring accuracy flow	±2%
	Min. flow measurement	0.5% of V'nom
	Measurement Repeatability	±0.5% (Flow)
	Sensor Technology	Ultrasonic with glycol and temperature compensation
Safety data	Degree of protection IEC/EN	IP66
	Degree of protection NEMA/UL	NEMA 4
	Enclosure	UL Enclosure Type 4
	Pressure equipment directive	CE according to 2014/68/EU
	Quality Standard	ISO 9001
	UL 2043 Compliant	Suitable for use in air plenums per Section 300.22(C) of the NEC and Section 602 of the IMC
	Rated impulse voltage supply / control	0.8 kV
	Ambient humidity	Max. 100% RH
	Ambient temperature	-22...122°F [-30...50°C]
	Storage temperature	-40...176°F [-40...80°C]
Materials	Valve body	Nickel-plated brass body
	Flow measuring pipe	brass body nickel-plated
	Valve plug	Stainless steel
	Stem	stainless steel
	Stem seal	EPDM (lubricated)
	Characterized disc	TEFZEL®
	Seat	PTFE
	Pipe connection	NPT
	O-ring	EPDM
	Ball	stainless steel
Terms	Abbreviations	POP = Power off position / fail-safe position PF = Power fail delay time / bridging time

Safety notes



- This device has been designed for use in stationary heating, ventilation and air-conditioning systems and must not be used outside the specified field of application, especially in aircraft or in any other airborne means of transport.
- Outdoor application: only possible in case that no (sea) water, snow, ice, insolation or aggressive gases interfere directly with the actuator and that is ensured that the ambient conditions remain at any time within the thresholds according to the data sheet.
- Only authorized specialists may carry out installation. All applicable legal or institutional installation regulations must be complied during installation.
- The device contains electrical and electronic components and must not be disposed of as household refuse. All locally valid regulations and requirements must be observed.

Product features

Application Water-side control of heating and cooling systems for AHUs and water coils.

Mode of operation The HVAC performance device is comprised of three components: characterized control valve (CCV), measuring pipe with flow sensor and the actuator itself. The adjusted maximum flow (V_{max}) is assigned to the maximum control signal (typically 100%). The HVAC performance device can be controlled via communicative signals. The fluid is detected by the sensor in the measuring pipe and is applied as the flow value. The measured value is balanced with the setpoint. The actuator corrects the deviation by changing the valve position. The angle of rotation α varies according to the differential pressure through the control element (see flow curves).

With the supply voltage the integrated condensers will be charged.

Interrupting the supply voltage causes the valve to be moved to the selected fail-safe position by means of stored electrical energy.

Flow measurement All flow tolerances are at 68°F [20°C] & water.

Flow rate curves

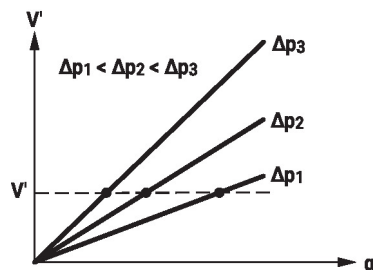

Pre-charging time (start up)

The capacitor actuators require a pre-charging time. This time is used for charging the capacitors up to a usable voltage level. This ensures that, in the event of a power failure, the actuator can move at any time from its current position into the preset fail-safe position.

The duration of the pre-charging time depends mainly on following factors:

- Duration of the power failure
- PF delay time (bridging time)

Typical pre-charging time

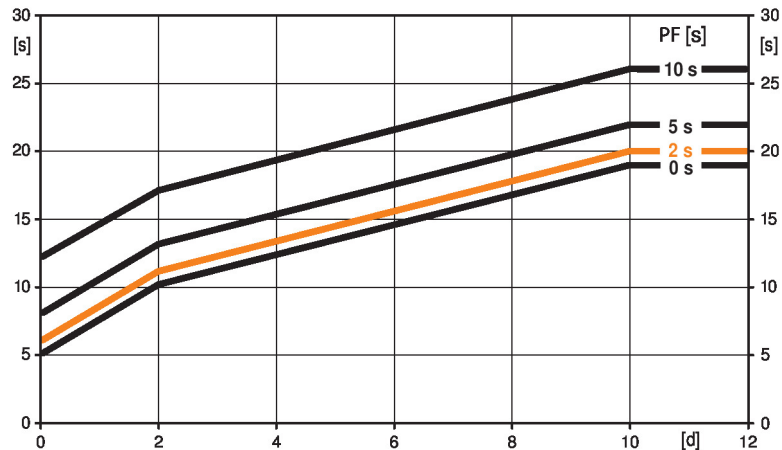

[d] = Power failure in days

[s] = Pre-charging time in seconds

PF[s] = Bridging time

Calculation example: Given a power failure of 3 days and a bridging time (PF) set at 5 s, the actuator requires a pre-charging time of 14 s after the power has been reconnected (see graphic).

PF [s]	[d]				
	0	1	2	7	≥10
0	5	8	10	15	19
2	6	9	11	16	20
5	8	11	13	18	22
10	12	15	17	22	26
	[s]				

Delivery condition (capacitors)

The actuator is completely discharged after delivery from the factory, which is why the actuator requires approximately 20 s pre-charging time before initial commissioning in order to bring the capacitors up to the required voltage level.

Bridging time

Power failures can be bridged up to a maximum of 10 s.

In the event of a power failure, the actuator will remain stationary in accordance with the set bridging time. If the power failure is greater than the set bridging time, the actuator will move into the selected fail-safe position.

The bridging time set at the factory is 2 s. It can be modified on site in operation by means of the Belimo service tool MFT-P.

Settings: The rotary knob must not be set to the "PROG FAIL-SAFE" position!

For retroactive adjustments of the bridging time with the Belimo service tool MFT-P or with the ZTH EU adjustment and diagnostic device only the values need to be entered.

Setting fail-safe position

The rotary knob fail-safe position can be used to adjust the desired fail-safe position 0...100% in 10% increments. The rotary knob always refers to the adapted angle-of-rotation range. In the event of a power failure, the actuator will move into the selected fail-safe position.

Settings: The rotary knob must be set to the «Tool» position for retroactive settings of the fail-safe position with the Belimo service tool MFT-P. Once the rotary knob is set back to the range 0...100%, the manually set value will have positioning authority.

Control characteristics

The fluid velocity is measured in the measuring component (sensor electronics) and converted to a flow rate signal.

The control signal Y corresponds to the power Q via the exchanger, the volumetric flow is regulated in the EPIV. The control signal Y is converted into a linear characteristic curve and provided with the $V'max$ value as the new reference variable w . The momentary control deviation forms the control signal $Y1$ for the actuator.

The specially configured control parameters in connection with the precise flow rate sensor ensure a stable quality of control. They are however not suitable for rapid control processes, i.e. for domestic water control. $U5$ displays the measured flow as voltage (factory setting).

Parametrizing $V'max$ with ZTH:

$U5$ refers to the respective $V'nom$, i.e. if $V'max$ is e.g. 50% of $V'nom$, then $Y = 10\text{ V}$, $U5 = 5\text{ V}$.

Parametrizing $V'max$ with PC-Tool:

In the PC-Tool, the maximum flow rate to which $U5$ refers can be set individually. If $V'max$ is changed (e.g. to 70% $V'nom$), the $U5$ flow range is also automatically changed to the same value (e.g. 70% $V'nom$: $U5 = 10\text{ V}$). This adjustment can be reversed by entering a value manually ($U5$ flow range = 100%: $U5$ refers to $V'nom$).

As an alternative, $U5$ can be used for displaying the valve opening angle.

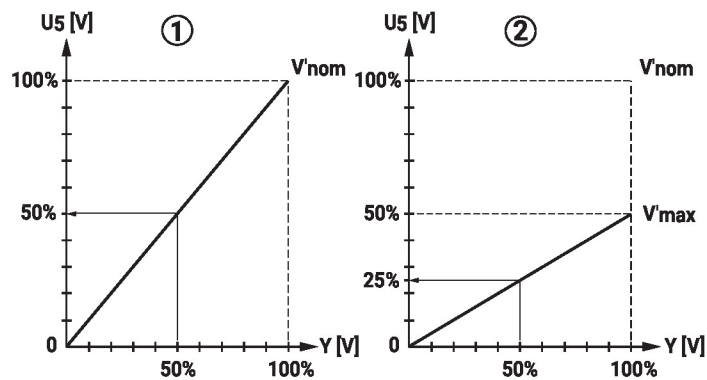
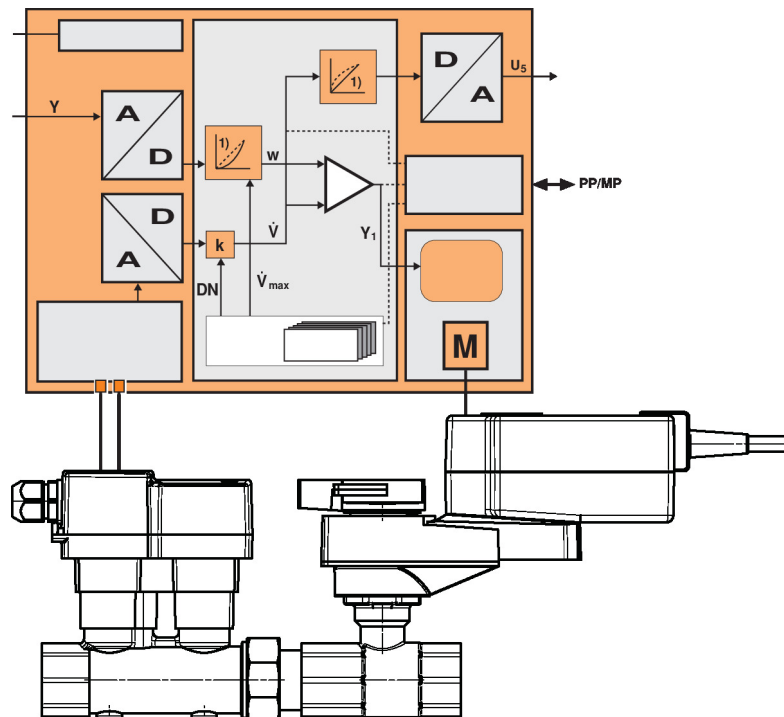
Block diagram

Flow control

V'nom is the maximum possible flow.

V'max is the maximum flow rate which has been set with the highest control signal DDC. V'max can be set between 25% and 100% of V'nom.

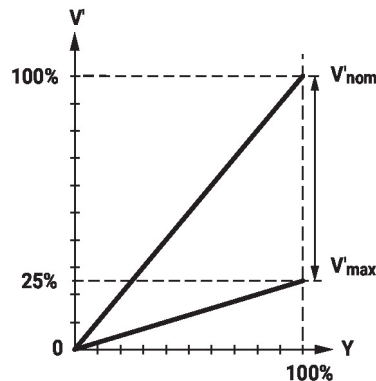

Creep flow suppression

Given the very low flow speed in the opening point, this can no longer be measured by the sensor within the required tolerance. This range is overridden electronically.

Opening valve

The valve remains closed until the flow required by the control signal DDC corresponds to 1% of V'nom. The control along the flow characteristic is active after this value has been exceeded.

Closing valve

The control along the flow characteristic is active up to the required flow rate of 1% of V'nom. Once the level falls below this value, the flow rate is maintained at 1% of V'nom. If the level falls below the flow rate of 0.5% of V'nom required by the control signal DDC, then the valve will close.

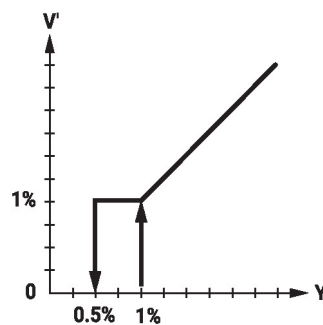

Converter for sensors

Connection option for a sensor (active or with switching contact). In this way, the analog sensor signal can be easily digitized and transferred to the bus systems BACnet, Modbus or MP-Bus.

Control signal inversion

This can be inverted in cases of control with an analog control signal. The inversion causes the reversal of the standard behavior, i.e. at a control signal of 0%, is equal to V'max, and the valve is closed at a control signal of 100%.

Hydronic balancing

With the Belimo tools, the maximum flow rate (equivalent to 100% requirement) can be adjusted on-site, simply and reliably, in a few steps. If the device is integrated in the management system, then the balancing can be handled directly by the management system.

Combination analogue - communicative (hybrid mode)

With conventional control by means of an analog control signal DDC, BACnet, Modbus, or MP-Bus can be used for the communicative position feedback.

Manual override

Manual control with push-button possible - temporary. The gear train is disengaged and the actuator decoupled for as long as the button is pressed.

Accessories

Tools	Description	Type
	Converter Bluetooth / NFC	ZIP-BT-NFC

Electrical installation



Supply from isolating transformer.

The wiring of the line for BACnet MS/TP / Modbus RTU is to be carried out in accordance with applicable RS485 regulations.

Modbus / BACnet: Supply and communication are not galvanically isolated. Connect earth signal of the devices with one another.

Modbus RTU / BACnet MS/TP with analogue setpoint (hybrid mode)

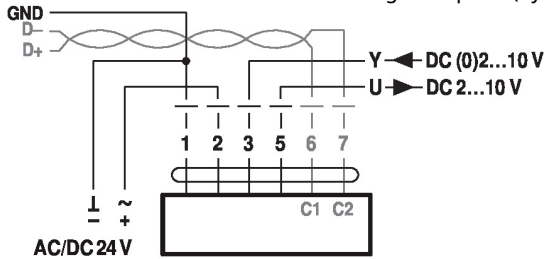

BACnet MS/TP / Modbus RTU

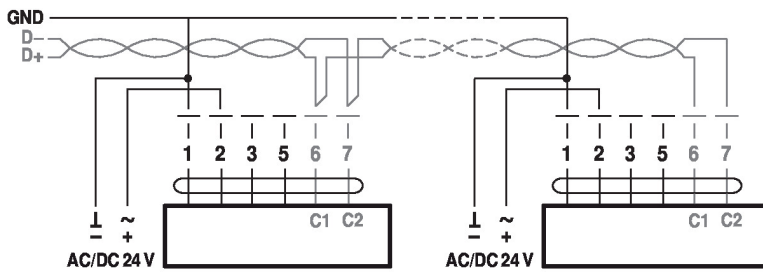

Cable colors:

- 1= black
- 2 = red
- 3 = white
- 5 = orange
- 6 = pink
- 7 = grey

BACnet / Modbus signal

assignment:

C1 = D- = A

C2 = D+ = B

Connection with active sensor, e.g. 0...10 V @ 0...50°C

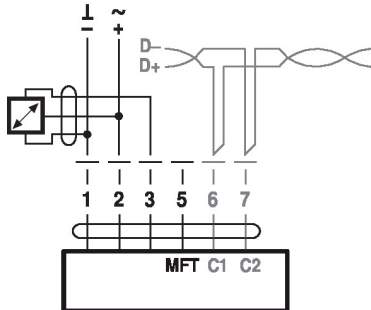

Possible voltage range:
0...32 V (resolution 30 mV)

Connection with switching contact, e.g. Δp monitor

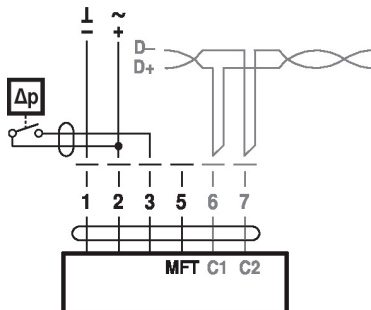

Requirements for switching contact:
The switching contact must be able to accurately switch a current of 16 mA @ 24 V.

Modbus RTU / BACnet MS/TP with analogue setpoint (hybrid mode)

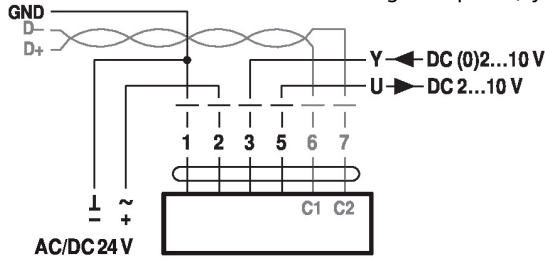

Operation on the MP-Bus

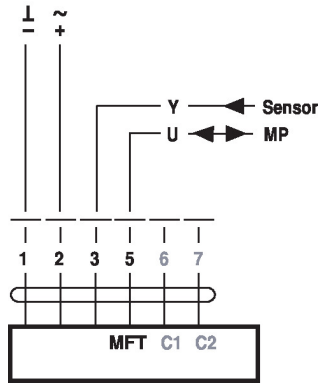

Connection with active sensor

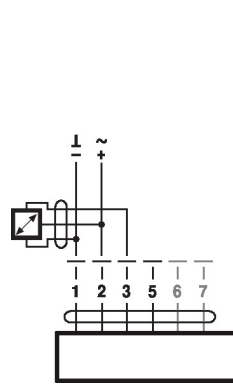

Functions

Functions with specific parameters (Parametrisation necessary)

M-Bus with converter in parallel mode with PoE with BACnet IP / Modbus TCP Examples of external wiring with actuator types ..24G..

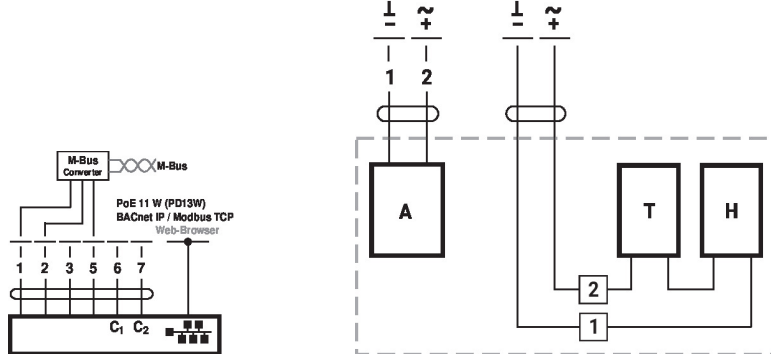

A = Actuator
T [°C] = Thermostat
H = Heating

Operating controls and indicators

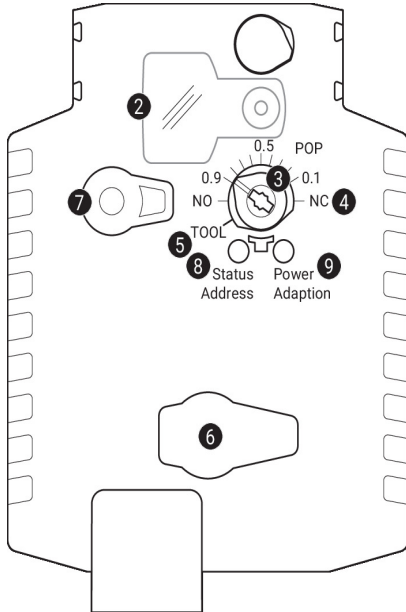

- 2 Cover, POP button
- 3 POP button
- 4 Scale for manual adjustment
- 5 Position for adjustment with tool
- 6 Service plug
For connecting parametrisation and service tools
- 7 Manual override button

Press button: Gear train disengages, motor stops, manual override possible
 Release button: Gear train engages, standard mode

LED displays

yellow 8	green 9	Meaning / function
Off	On	Operation OK
Off	Flashing	POP function active
On	Off	Fault
Off	Off	Not in operation
On	On	Adaptation or synchronisation process active
Flickering	On	MP-Bus communication active

8 Push-button (LED yellow)

Press button: Acknowledgment of addressing

9 Push-button (LED green)

Press button: Triggers angle of rotation adaptation, followed by standard mode

Setting fail-safe position

Setting emergency setting position (POP)

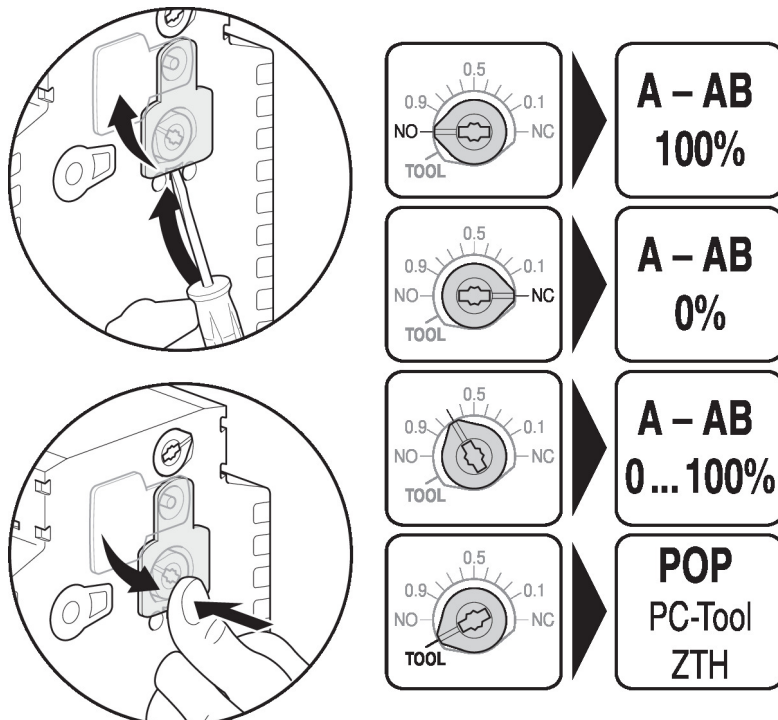

Installation notes

Recommended installation positions The ball valve can be installed upright to horizontal. The ball valve may not be installed in a hanging position, i.e. with the stem pointing downwards.

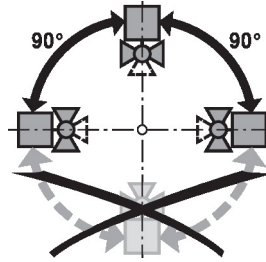

Installation position in return Installation in the return is recommended.

Water quality requirements The water quality requirements specified in VDI 2035 must be adhered to. Belimo valves are regulating devices. For the valves to function correctly in the long term, they must be kept free from particle debris (e.g. welding beads during installation work). The installation of a suitable strainer is recommended.

Servicing Ball valves, rotary actuators and sensors are maintenance-free. Before any service work on the control element is carried out, it is essential to isolate the rotary actuator from the power supply (by unplugging the electrical cable if necessary). Any pumps in the part of the piping system concerned must also be switched off and the appropriate slide valves closed (allow all components to cool down first if necessary and always reduce the system pressure to ambient pressure level). The system must not be returned to service until the ball valve and the rotary actuator have been correctly reassembled in accordance with the instructions and the pipeline has been refilled by professionally trained personnel.

Flow direction The direction of flow, specified by an arrow on the housing, is to be complied with, since otherwise the flow rate will be measured incorrectly.

Cleaning of pipes Before installing the valve, the circuit must be thoroughly rinsed to remove impurities.

Prevention of stresses The valve must not be subjected to excessive stress caused by pipes or fittings.

Inlet section In order to achieve the specified measuring accuracy, a flow-calming section or inflow section in the direction of the flow is to be provided upstream from the flow sensor. Its dimensions should be at least 5x DN.

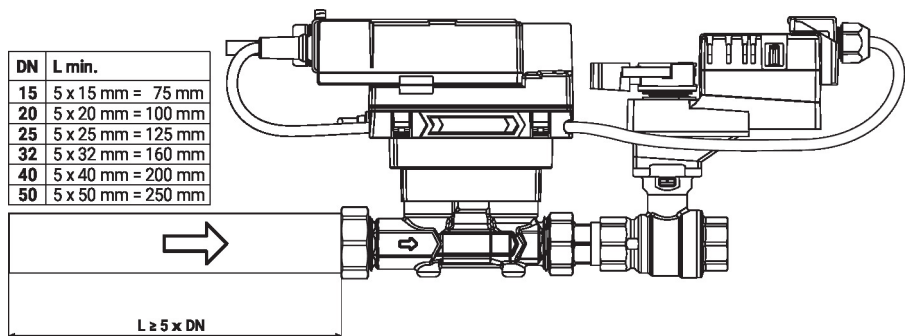

Split installation The valve-actuator combination may be mounted separately from the flow sensor. The direction of flow of both components must be observed.

General notes

Behaviour in case of sensor failure In case of a flow sensor error, the EPIV will switch from flow control to position control. Once the error disappears, the EPIV will switch back to the normal control setting.

Dimensions

Dimensional drawings

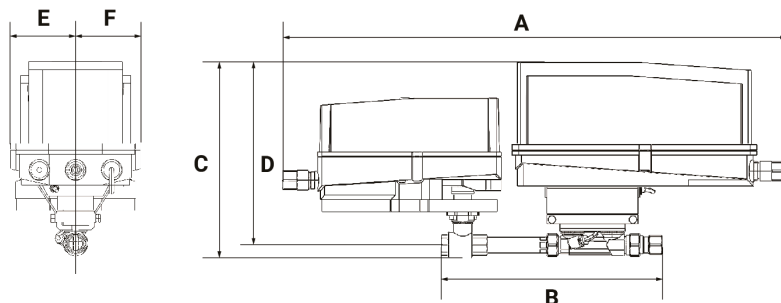

Type

EP150+AKRX-E N4HT

Weight

□

A	B	C	D	E	F
26.6" [675]	14.5" [368]	11.5" [292]	10.0" [254]	3.4" [86]	3.4" [86]