



H808

Solid-Core Current Switch, Adjustable Trip Point

Product Overview

The H808 is a current-sensitive switching device that monitors current (amperage) in the conductor passing through it. A change in amperage in the monitored conductor that crosses the switch threshold plus the hysteresis value will cause the resistance of the status output to change state, similar to the action of a mechanical switch. The setpoint is adjustable through the action of a 20-turn potentiometer (see Calibration section). The status output is suitable for connection to building controllers or other appropriate data acquisition equipment operating at up to 30 volts. The H808 requires no external power supply to generate its output.



⚠️ ⚠️ DANGER

HAZARD OF ELECTRIC SHOCK, EXPLOSION, OR ARC FLASH

- Follow safe electrical work practices. See NFPA 70E in the USA, or applicable local codes.
- This equipment must only be installed and serviced by qualified electrical personnel.
- Read, understand and follow the instructions before installing this product.
- Turn off all power supplying equipment before working on or inside the equipment.
- Use a properly rated voltage sensing device to confirm power is off.
- DO NOT DEPEND ON THIS PRODUCT FOR VOLTAGE INDICATION**
- Only install this product on insulated conductors.

Failure to follow these instructions will result in death or serious injury.

A qualified person is one who has skills and knowledge related to the construction and operation of this electrical equipment and the installation, and has received safety training to recognize and avoid the hazards involved. NEC2009 Article 100
No responsibility is assumed by Veris Industries for any consequences arising out of the use of this material.

NOTICE

- This product is not intended for life or safety applications.
- Do not install this product in hazardous or classified locations.
- The installer is responsible for conformance to all applicable codes.
- Mount this product inside a suitable fire and electrical enclosure.

Specifications

Sensor Power	Induced from the monitored conductor
Amperage Range	0.75 to 50 A continuous*
Status Output Ratings	N.O. 1.0 A@30 VAC/DC, not polarity sensitive
Insulation Class	600 VAC RMS (UL); 300 VAC (CE)
Setpoint	Adjustable, 0.75 A or less
Frequency Range	50/60 Hz
Temperature Range	-15° to 60°C (5° to 140°F)
Humidity Range	10-90% RH non-condensing
Hysteresis	10% typical
Off State Resistance	Open switch represents >1 MΩ
On State Resistance	Closed switch represents < 200 mΩ
Terminal Block Wire Size	24 to 14 AWG (0.2 to 2.1 mm ²)
Terminal Block Torque	3.5 to 4.4 in-lbs (0.4 to 0.5 N-m)
COMPLIANCE INFORMATION	
Agency Approvals	UL508 open device listing, CE: EN61010-1
Installation Category	Cat. III, pollution degree 2

Specification Note: For CE compliance, conductor shall be insulated according to IEC 61010-1:2010. The product design provides basic insulation only.

Do not use the LED indicators as evidence of applied voltage.

** When operating at 50 Hz, low threshold may be 0.9 A.*

Dimensions

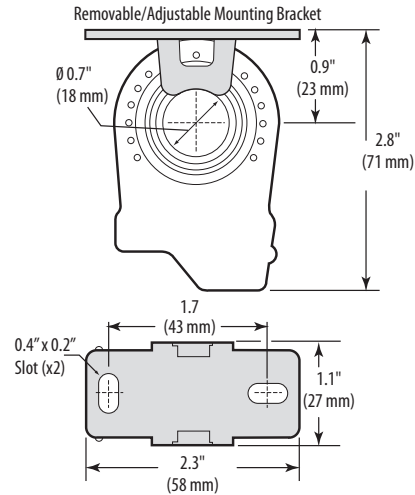

Installation

⚠️ Disconnect and lock out power to the enclosure containing the conductor to be monitored.

1. Locate a mounting surface for the removable mounting bracket that will allow the monitored conductor to pass through the center window when it is installed and that will keep the device at least ½" (13 mm) from any uninsulated conductors. Determine cable routing for the controller connection, allowing wiring to reach the mounting location.
2. Drill holes to mount the bracket to the chosen surface using the included screws.
3. Wire the output connections and relay between the sensor and the controller (solid-state contact).
4. Route the conductor through the sensor's center window and slip the assembly into the mounting bracket.
5. Secure the enclosure and reconnect power.
6. Calibrate the sensor with the load running normally.

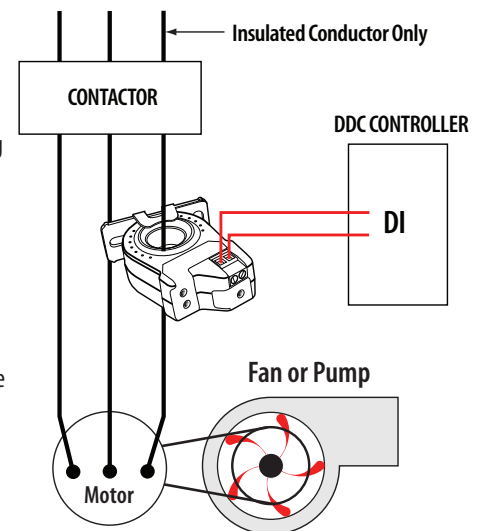

Notes

For load currents greater than sensor maximum rating:

Use a 5 Amp (H68xx series) current transformer (CT) as shown. This technique can be combined with wrapping (see below) to add range for a low current load on a high current source.

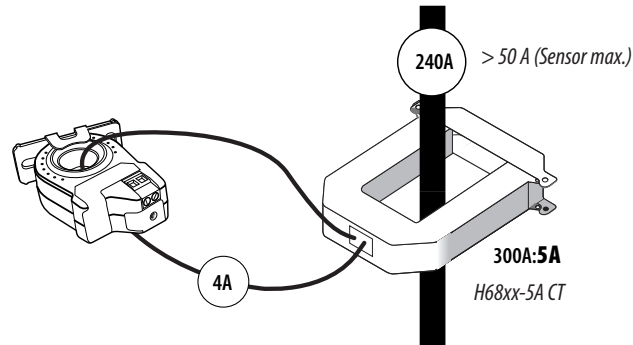

DANGER: 5A CTs can present hazardous voltages. Install CTs in accordance with manufacturer's instructions. Terminate the CT secondary before applying current.

For load currents less than sensor minimum rating:

Wrap the monitored conductor through the center window and around the sensor body to produce multiple turns. This increases the current measured by the transducer. Program the controller to account for the extra turns (e.g., if four turns pass through the sensor (as shown) divide the normal reading by 4).

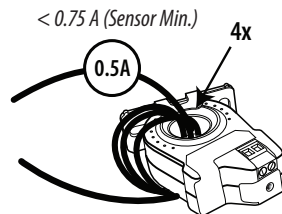

CAUTION

RISK OF EQUIPMENT DAMAGE

- Derate the product's maximum current for the number of turns through the sensing window using the following formula.
Rated Max. Amps ÷ Number of Turns = Max. monitored Amps
e.g.: 100A ÷ 4 Turns = 25 Amps max. in monitored conductor
- Failure to follow these instructions can result in overheating and permanent equipment damage.

Calibration

Before beginning calibration, establish normal load conditions. Then choose either A or B below.

A. To monitor under-current (belt loss, coupling shear, status)

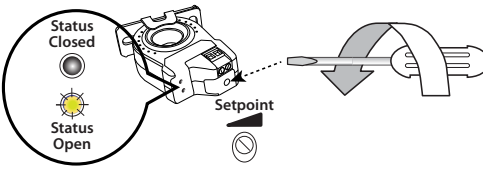
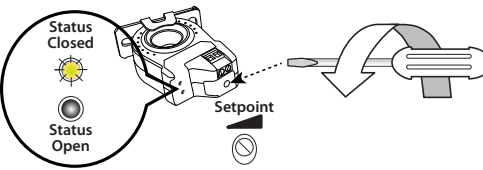
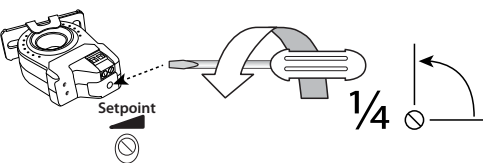
1. Turn setpoint screw clockwise until Status Open LED turns on.
 
2. Slowly turn the screw counter clockwise until the Status Closed LED turns on.
 
3. Turn the screw an additional 1/4 turn counter clockwise for operational margin.
 

B. To monitor over-current (mechanical problems, seized impeller)

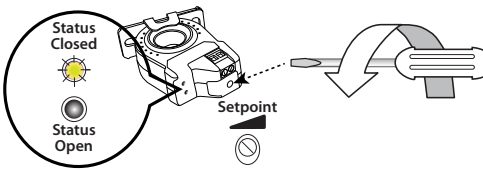
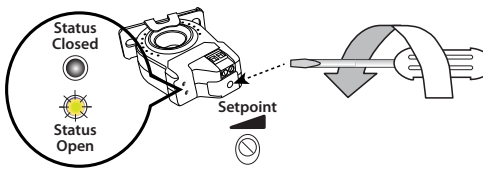
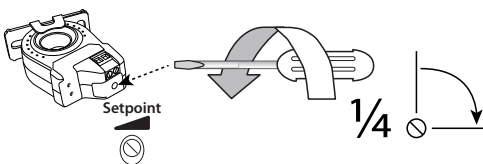
1. Turn setpoint screw counter clockwise until Status Closed LED turns on.
 
2. Slowly turn the setpoint screw clockwise until the Status Open LED just turns on.
 
3. Turn the setpoint screw an additional 1/4 turn clockwise for operational margin.
 

Troubleshooting

Problem	Solution
No Reading at Controller	<ul style="list-style-type: none"> • Check sensor calibration (see above) • Check for control power at sensor (<30VDC) • Check for amperage in monitored conductor (>0.75A)
Setpoint screw has no stops	<ul style="list-style-type: none"> • The setpoint screw has a slip-clutch at both ends of its travel to avoid damage. Twenty turns CCW will reset the sensor to be most sensitive. Repeat calibration above.
Both LEDs are lit	Unit is out of calibration. Turn screw 20 turns CCW and recalibrate.